

S-5![®]

The Right Way!

S-5-N Clamp

S-5-N and S-5-N Mini clamps were designed with patented S-5![®] zero-penetration technology for application on the popular 1" nail strip metal roof profiles: Taylor Metals' Easy Lock[™], ASC Building Products' Skyline Roofing[®], McElroy Metals' Meridian, New Tech Machinery's FF100, and roofing types with similar profiles. The clamp boasts a wider throat that accommodates most nail strip profiles, minimizing the need to field crimp. An angled wall with a nose permits the S-5-N to engage the triangle type profiles during the installation process—there is no longer a need to hold the clamp in place while setscrews are tensioned. The combination of these two features allows the clamp to sit straighter on the seam. Nail strip profiles just got a whole lot simpler!

S-5-N Mini Clamp

The S-5-N Mini is a bit shorter than the S-5-N and has one setscrew rather than two. The Mini is the choice for attaching all kinds of rooftop accessories: signs, walkways, satellite dishes, antennas, rooftop lighting, lightning protection systems, solar arrays, exhaust stack bracing, conduit, condensate lines, mechanical equipment—just about anything!*

*S-5! Mini clamps are not compatible with, and should not be used with, S-5! SnoRail[™]/SnoFence[™] or ColorGard[®] snow retention systems.

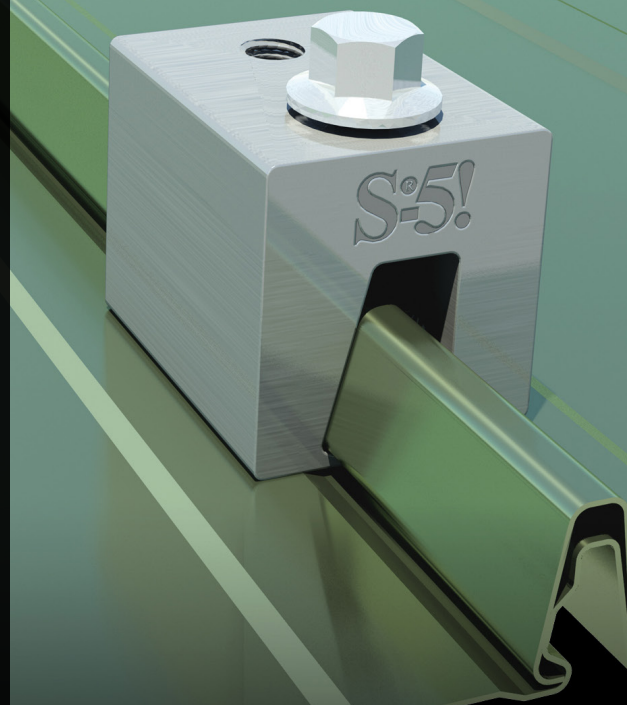
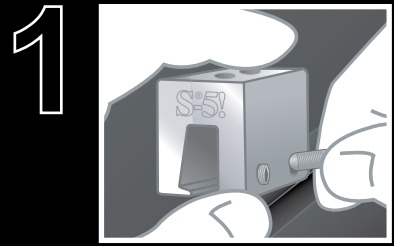

The S-5-N clamp is designed for use on the most popular 1" nail strip metal roofs.

S-5-N and S-5-N Mini

888-825-3432 | www.S-5.com

The right way to attach almost anything to metal roofs!

S-5![®]

The Right Way!

The S-5-N boasts a wider throat that accommodates most nail strip profiles, minimizing the need to field crimp.

The **S-5-N and S-5-N Mini clamps** are each furnished with the hardware shown to the right. Each box also includes a bit tip for tightening setscrews using an electric screw gun. A structural aluminum attachment clamp, the S-5-N is compatible with most common metal roofing materials excluding copper. All included hardware is 300 series stainless steel. Please visit www.S-5.com for more information including CAD details, metallurgical compatibilities, and specifications.

The S-5-N clamp has been tested for load-to-failure results on most major brands of 1" nail strip profiles of standing seam roofing. The independent lab test data found at www.S-5.com can be used for load-critical designs and applications. S-5![®] holding strength is unmatched in the industry.

Example Profiles

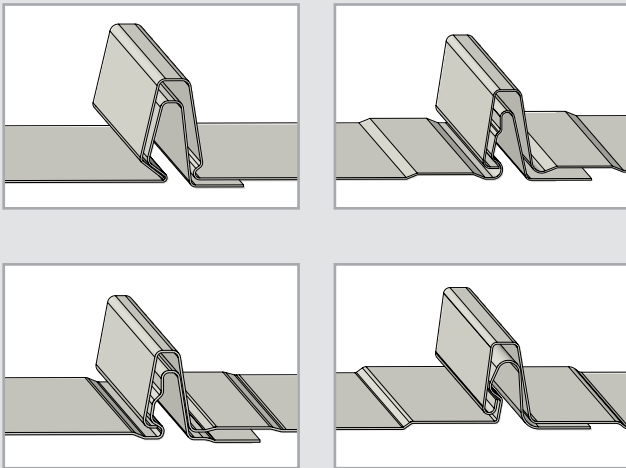

S-5-N Clamp

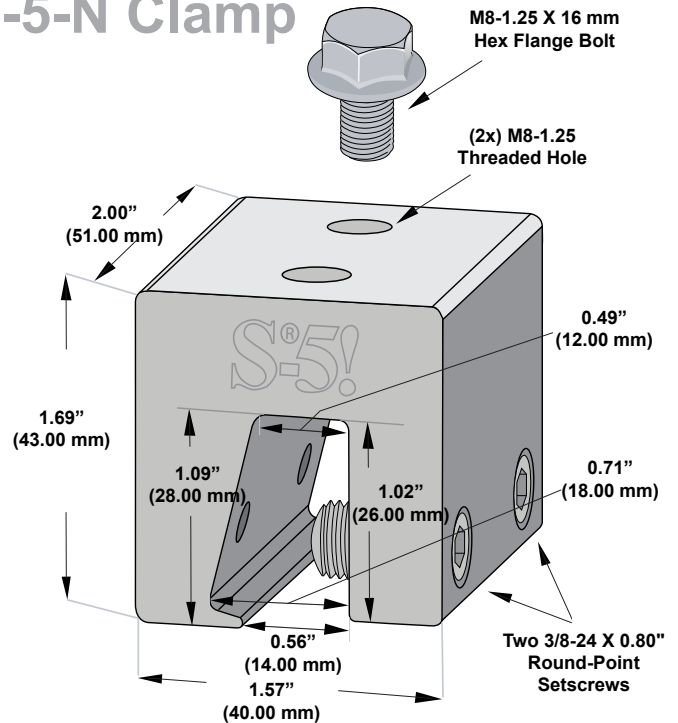

S-5-N Mini Clamp

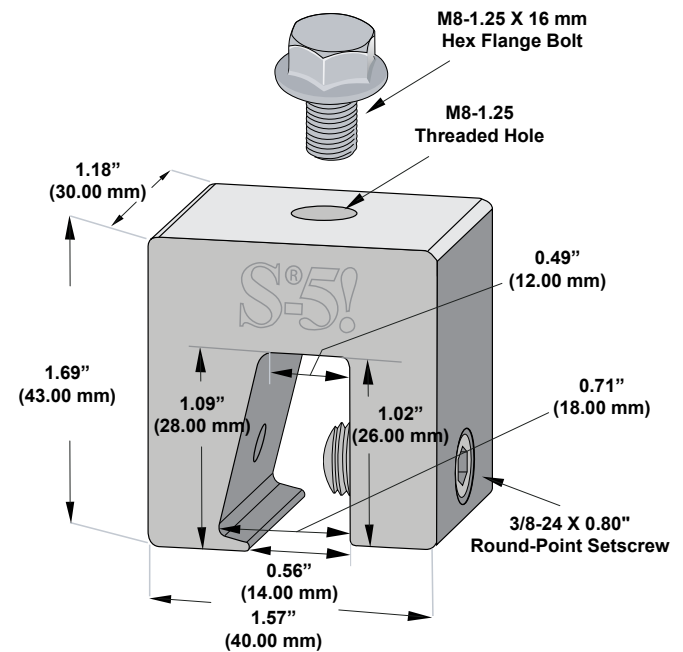

Please note: All measurements are rounded to the second decimal place.

S-5![®] Warning! Please use this product responsibly!

Products are protected by multiple U.S. and foreign patents. Visit the website at www.S-5.com for complete information on patents and trademarks. For maximum holding strength, setscrews should be tensioned and re-tensioned as the seam material compresses. Clamp setscrew tension should be verified using a calibrated torque wrench between 160 and 180 inch pounds when used on 22ga steel, and between 130 and 150 inch pounds for all other metals and thinner gauges of steel. Consult the S-5! website at www.S-5.com for published data regarding holding strength.

Copyright 2015, Metal Roof Innovations, Ltd. S-5! products are patent protected. S-5! aggressively protects its patents, trademarks, and copyrights. Version 031915.

Distributed by